

What's New in Ptolemy



Presented by Alan Kamas
Ptolemy MiniConference 1995

Shuvra Bhattacharyya
Joseph T. Buck
Wan-Teh Chang
Brian L. Evans
Steve X. Gu
Sangjin Hong
Christopher Hylands
Asawaree Kalavade
Alan Kamas
Allen Lao
Bitung Lee
Edward A. Lee
David G. Messerschmitt
Praveen K. Murthy
Thomas M. Parks
José Luis Pino
Farhana Shiekh
S. Sriram
Juergen Teich
Warren W. Tsai
Patrick J. Warner
Michael C. Williamson

UNIVERSITY OF CALIFORNIA AT BERKELEY

What's New in Ptolemy

- What's new during the last year
- Preview of the Ptolemy 0.5.2 Release
- Looking forward to Ptolemy 0.6



UNIVERSITY OF CALIFORNIA AT BERKELEY

What's New This Year

New Releases

- Ptolemy 0.5
- Ptiny 0.5
- Ptolemy 0.5.1

New Ports

- Solaris 2
- HP-Precision Architecture
- Silicon Graphics Irix 5
- Linux (PCs)

World Wide Web site

- <http://ptolemy.eecs.berkeley.edu>

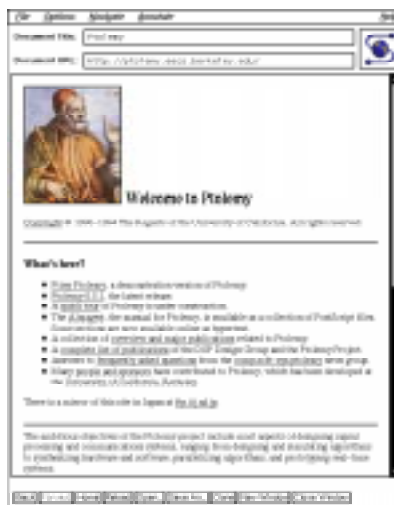

UNIVERSITY OF CALIFORNIA AT BERKELEY

What's New This Year

New Domains

- Boolean DataFlow
- Message Queue
- Multidimensional Data Flow
- Silage Code Generation
- Sproc Code Generation
- VHDL Code Generation

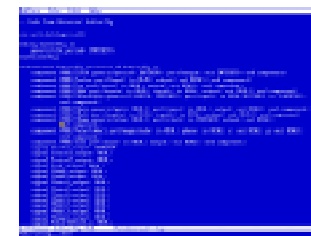
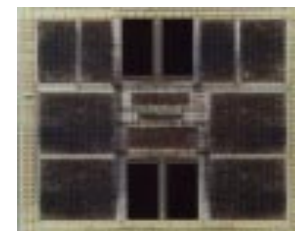
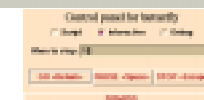
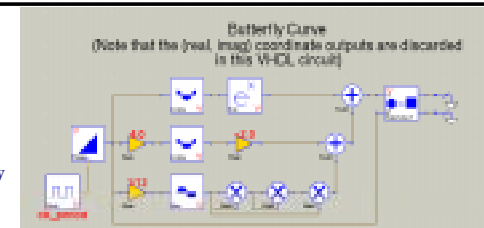

UNIVERSITY OF CALIFORNIA AT BERKELEY

What's New This Year

- Fixed Point Class
- Matrix Class
- Higher Order Functions
- Matlab Interface
- Initializable Delays

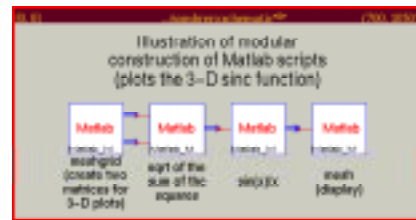
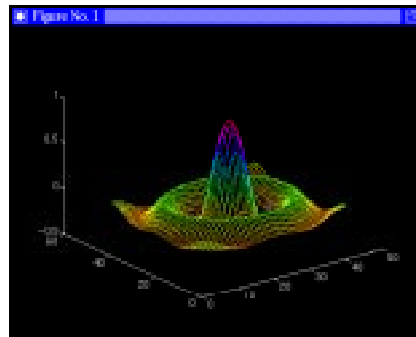

UNIVERSITY OF CALIFORNIA AT BERKELEY

What's New This Year

- New Event Driven Graphical User Interface
 - animated runs and displays
 - each star has access to Tcl and Tk

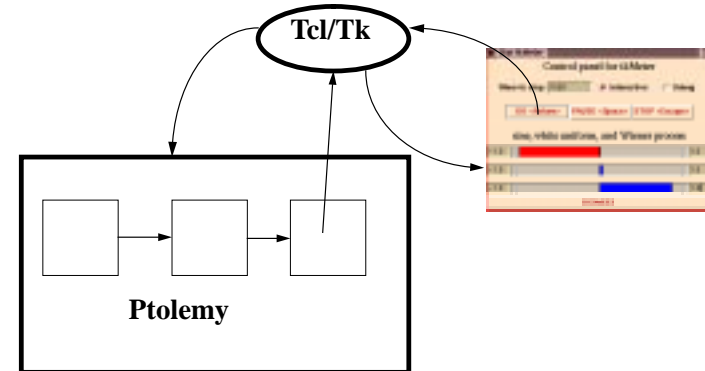

UNIVERSITY OF CALIFORNIA AT BERKELEY

The Ptolemy 0.5.2 Release

Ptolemy 0.5.2:

- Alpha release planned for March 1995
- Ptrim - Medium sized version of Ptolemy
- Speed Improvements
- Scripted Runs
- Conditional Breakpoints
- New Graphics and Animation
- Higher Order Functions in the C Code Generation domain
- Fixed Point in the C Code Generation domain
- New Image Processing stars

UNIVERSITY OF CALIFORNIA AT BERKELEY

The Ptolemy 0.5.2 Release

- Speed Improvements
 - Timer Based Event Loop
 - Optimally checked for user actions
 - Ensures both interactivity and efficiency

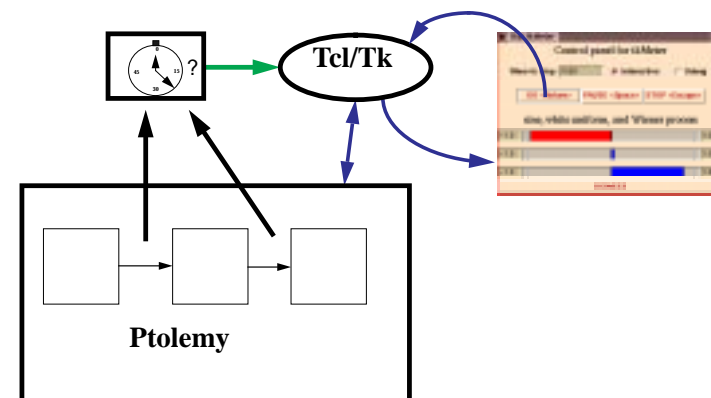

UNIVERSITY OF CALIFORNIA AT BERKELEY

The Ptolemy 0.5.2 Release

• Scripted Runs

- Can use any tcl commands to control the run
- Star parameters can be set by Tcl
- Control structures such as “For” and “While” loops
- Multiple runs with Varying parameters

```
set position 0
foreach freq {PI/100 PI/200 PI/400} {
  setstate singen1 frequency $freq
  setstate XMgraph.input=11 \
    option “=800x300+0+$position -0 x”
  incr position 300
  run 400
  wrapup }

```

UNIVERSITY OF CALIFORNIA AT BERKELEY

The Ptolemy 0.5.2 Release

• Conditional Breakpoint Star

- Executes Tcl script if the inputs reach the specified condition

```
set noise 1.5
set fd [open /tmp/xmitber_results w]
ptkInform .xmitber “Running simulation with noise level $noise”
while { $noise >= 0.7 } {
  setstate AWGNchannel1 noisePwr $noise
  run 100000
  set error_rate [expr 40.0/[schedtime]]
  ptkInform .xmitber [format “noise = %4.2f symbol error rate = %f” $noise $error_rate]
  puts $fd “$noise $error_rate”
  wrapup
  set noise [expr $noise - 0.10]
}
close $fd
exec pxgraph -tk -bb =800x400+0+0 -t probability_of_error /tmp/xmitber_results
exec rm /tmp/xmitber_results
ptkSafeDestroy .xmitber

```

UNIVERSITY OF CALIFORNIA AT BERKELEY

The Ptolemy 0.5.2 Release

• Graphics and Animation Demonstrations

- Buttons
- Eye Diagram
- Phased Array
- DE: Strip Chart
- DE: Display Demonstration
- CGC: Noisy Sine (HOF in CGC)

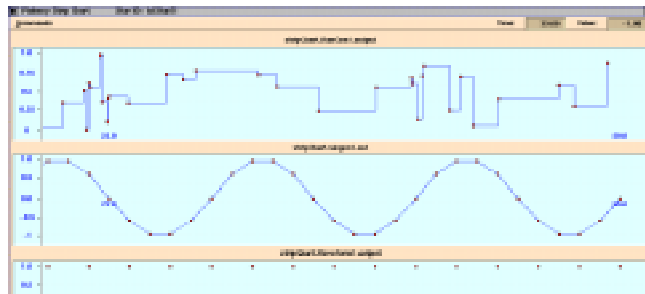

UNIVERSITY OF CALIFORNIA AT BERKELEY

The Ptolemy 0.5.2 Release

• Image Processing Demonstrations

- Dither
- Edge Detection



UNIVERSITY OF CALIFORNIA AT BERKELEY

Preview of Ptolemy 0.6

Ptolemy 0.6 will contain a *subset* of

- Design Methodology Management
- New Code Generation Schedulers and Interfaces
- Process Networks Domain
- VHDL retargeting
- Esterel Interface
- Finite State Machine Controller
- Mathematica Interface for Symbolic Computation
- RS6000 Port
- Improved Test Suite

UNIVERSITY OF CALIFORNIA AT BERKELEY

Preview of Ptolemy 0.6

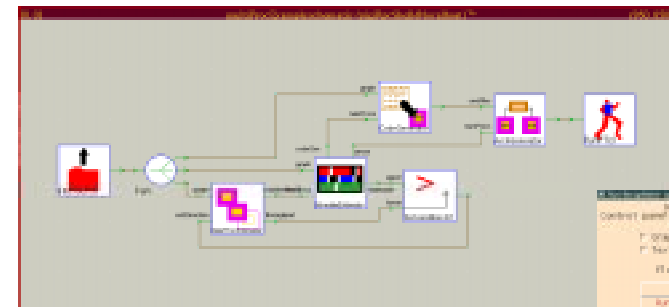

- Design Methodology Management Domain
 - Structure to support tools like the Design Assistant
- Design Assistant
 - HW/SW codesign starting from an SDF description
 - Partitioning Tools
 - Synthesis of Hardware, Software, and the Interface between them

UNIVERSITY OF CALIFORNIA AT BERKELEY

Preview of Ptolemy 0.6

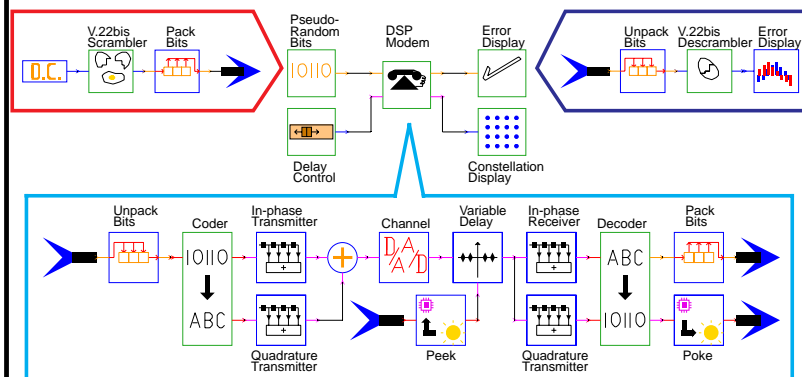

- Heterogeneous Hierarchical Schedules for Code Generation
- Code Generation Wormhole
- Galaxies to Stars
 - compile Code Generation galaxies into a single star

UNIVERSITY OF CALIFORNIA AT BERKELEY

Preview of Ptolemy 0.6

- VHDL Code Generation for Simulation and Synthesis
 - new VHDL stars
 - retargeting from DataFlow to VHDL

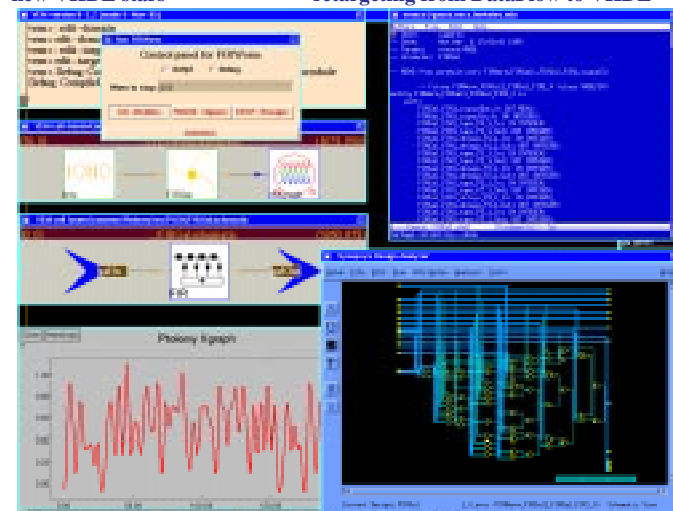

UNIVERSITY OF CALIFORNIA AT BERKELEY

Looking Further into the Future

Publications

- Look to our WWW site for the latest Ptolemy publications
 - <http://ptolemy.eecs.berkeley.edu>
 - f(x): ptolemy.eecs.berkeley.edu/pub/ptolemy/papers

Discussion Groups

- Newsgroup
 - comp.soft-sys.ptolemy
- Mailing List
 - ptolemy-hackers@dewitt.eecs.berkeley.edu

